

User Manual

IMD

**Intelligent
Mail
Device**

Draft Feb 20, 2005

**Models
F3124A & F3125A**



6802975C55-O



COMPUTER SOFTWARE COPYRIGHTS

The Motorola products described in this instruction manual may include copyrighted Motorola computer programs stored in semiconductor memories or other media. Laws in the United States and other countries preserve for Motorola certain exclusive rights for copyrighted computer programs, including the exclusive right to copy or reproduce in any form the copyrighted computer program. Accordingly, any copyrighted Motorola computer programs contained in the Motorola products described in this instruction manual may not be copied or reproduced in any manner without the express written permission of Motorola. Furthermore, the purchase of Motorola products shall not be deemed to grant either directly or by implication, estoppel, or otherwise, any license under the copyrights, patents or patent applications of Motorola, except for the normal non-exclusive, royalty free license to use that arises by operation of law in the sale of a product.
EPS – 34440- B

This warranty applies within the fifty (50) United States, the District of Columbia and Canada.

Document Copyrights

No duplication or distribution of this document or any portion thereof shall take place without the express written permission of Motorola. No part of this manual may be reproduced, distributed, or transmitted in any form or by any means, electronic or mechanical, for any purpose without the express written permission of Motorola.

Disclaimer

The information in this document is carefully examined, and is believed to be entirely reliable. However, no responsibility is assumed for inaccuracies. Furthermore, Motorola reserves the right to make changes to any products herein to improve readability, function, or design. Motorola does not assume any liability arising out of the applications or use of any product or circuit described herein, nor does it cover any license under its patent rights nor the rights of others.

Commercial Warranty

Limited Warranty

MOTOROLA COMMUNICATION PRODUCTS

I. What This Warranty Covers And For How Long

MOTOROLA INC. ("MOTOROLA") warrants the MOTOROLA manufactured Communication Products listed below ("Product") against defects in material and workmanship under normal use and service for a period of time from the date of purchase as scheduled below:

IMD unit	One (1) Year
Product Accessories	One (1) Year

Motorola, at its option, will at no charge either repair the Product (with new or reconditioned parts), replace it (with a new or reconditioned Product), or refund the purchase price of the Product during the warranty period provided it is returned in accordance with the terms of this warranty. Replaced parts or boards are warranted for the balance of the original applicable warranty period. All replaced parts of Product shall become the property of MOTOROLA.

This express limited warranty is extended by MOTOROLA to the original end user purchaser only and is not assignable or transferable to any other party. This is the complete warranty for the Product manufactured by MOTOROLA. MOTOROLA assumes no obligations or liability for additions or modifications to this warranty unless made in writing and signed by an officer of MOTOROLA. Unless made in a separate agreement between MOTOROLA and the original end user purchaser, MOTOROLA does not warrant the installation, maintenance or service of the Product.

MOTOROLA cannot be responsible in any way for any ancillary equipment not furnished by MOTOROLA which is attached to or used in connection with the Product, or for operation of the Product with any ancillary equipment, and all such equipment is expressly excluded from this warranty. Because each system which may use the Product is unique, MOTOROLA disclaims liability for range, coverage, or operation of the system as a whole under this warranty.

II. General Provisions

This warranty sets forth the full extent of MOTOROLA's responsibilities regarding the Product. Repair, replacement or refund of the purchase price, at MOTOROLA's option, is the exclusive remedy. THIS WARRANTY IS GIVEN IN LIEU OF ALL OTHER EXPRESS WARRANTIES. IMPLIED WARRANTIES, INCLUDING WITH-

OUT LIMITATION, IMPLIED WARRANTIES OF MERCHANTABILITY AND FITNESS FOR A PARTICULAR PURPOSE, ARE LIMITED TO THE DURATION OF THIS LIMITED WARRANTY. IN NO EVENT SHALL MOTOROLA BE LIABLE FOR DAMAGES IN EXCESS OF THE PURCHASE PRICE OF THE PRODUCT, FOR ANY LOSS OF USE, LOSS OF TIME, INCONVENIENCE, COMMERCIAL LOSS, LOST PROFITS OR SAVINGS OR OTHER INCIDENTAL, SPECIAL OR CONSEQUENTIAL DAMAGES ARISING OUT OF THE USE OR INABILITY TO USE SUCH PRODUCT, TO THE FULL EXTENT SUCH MAY BE DISCLAIMED BY LAW.

III. State Law Rights

SOME STATES DO NOT ALLOW THE EXCLUSION OR LIMITATION OF INCIDENTAL OR CONSEQUENTIAL DAMAGES OR LIMITATION ON HOW LONG AN IMPLIED WARRANTY LASTS, SO THE ABOVE LIMITATION OR EXCLUSIONS MAY NOT APPLY.

This warranty gives specific legal rights, and there may be other rights which may vary from state to state.

IV. How To Get Warranty Service

You must provide proof of purchase (bearing the date of purchase and Product item serial number) in order to receive warranty service and, also, deliver or send the Product item, transportation and insurance prepaid, to an authorized warranty service location. Warranty service will be provided by Motorola through one of its authorized warranty service locations. If you first contact the company which sold you the Product, it can facilitate your obtaining warranty service. You can also call Motorola at 1-888-567-7347 US/Canada.

V. What This Warranty Does Not Cover

- A. Defects or damage resulting from use of the Product in other than its normal and customary manner.
- B. Defects or damage from misuse, accident, water, or neglect.
- C. Defects or damage from improper testing, operation, maintenance, installation, alteration, modification, or adjustment.
- D. Breakage or damage to antennas unless caused directly by defects in material workmanship.
- E. A Product subjected to unauthorized Product modifications, disassemblies or repairs (including, without limitation, the addition to the Product of non-Motorola supplied equipment) which adversely affect performance of the Product or interfere with Motorola's normal war-

ranty inspection and testing of the Product to verify any warranty claim.

F. Product which has had the serial number removed or made illegible.

G. Rechargeable batteries if:

- any of the seals on the battery enclosure of cells are broken or show evidence of tampering.
- the damage or defect is caused by charging or using the battery in equipment or service other than the Product for which it is specified.

H. Freight costs to the repair depot.

I. A Product which, due to illegal or unauthorized alteration of the software/firmware in the Product, does not function in accordance with MOTOROLA's published specifications or the FCC type acceptance labeling in effect for the Product at the time the Product was initially distributed from MOTOROLA.

J. Scratches or other cosmetic damage to Product surfaces that does not affect the operation of the Product.

K. Normal and customary wear and tear.

VI. Patent And Software Provisions

MOTOROLA will defend, at its own expense, any suit brought against the end user purchaser to the extent that it is based on a claim that the Product or parts infringe a United States patent, and MOTOROLA will pay those costs and damages finally awarded against the end user purchaser in any such suit which are attributable to any such claim, but such defense and payments are conditioned on the following:

- A. that MOTOROLA will be notified promptly in writing by such purchaser of any notice of such claim;
- B. that MOTOROLA will have sole control of the defense of such suit and all negotiations for its settlement or compromise; and
- C. should the Product or parts become, or in MOTOROLA's opinion be likely to become, the subject of a claim of infringement of a United States patent, that such purchaser will permit MOTOROLA, at its option and expense, either to procure for such purchaser the right to continue using the Product or parts or to replace or modify the same so that it becomes noninfringing or to grant such purchaser a credit for the Product or parts as depreciated and accept its return. The depreciation will be an equal amount per year over the lifetime of the Product or parts as established by MOTOROLA.

MOTOROLA will have no liability with respect to any claim of patent infringement which is based upon the combination of the Product or parts furnished hereunder

with software, apparatus or devices not furnished by MOTOROLA, nor will MOTOROLA have any liability for the use of ancillary equipment or software not furnished by MOTOROLA which is attached to or used in connection with the Product. The foregoing states the entire liability of MOTOROLA with respect to infringement of patents by the Product or any parts thereof.

Laws in the United States and other countries preserve for MOTOROLA certain exclusive rights for copyrighted MOTOROLA software such as the exclusive rights to reproduce in copies and distribute copies of such Motorola software. MOTOROLA software may be used in only the Product in which the software was originally embodied and such software in such Product may not be replaced, copied, distributed, modified in any way, or used to produce any derivative thereof. No other use including, without limitation, alteration, modification, reproduction, distribution, or reverse engineering of such MOTOROLA software or exercise of rights in such MOTOROLA software is permitted. No license is granted by implication, estoppel or otherwise under MOTOROLA patent rights or copyrights.

VII. Governing Law

This Warranty is governed by the laws of the State of Illinois, USA.

EPS – 48759 – O

Grant of Equipment Authorization

Model Differences

The IMD is provided in two model versions - F3124A and F3125A. The two models differ only by the incorporation of the following radio modules:

Model F3124A is equipped with Wi-Fi 802.11b and Bluetooth radios

Model F3125A is equipped with Bluetooth radio

FCC Grant of Equipment Authorization

FCC ID: AZ489FT7015

Canada Grant of Equipment Authorization

IC: 109U-89FT7015

Radio	Network	Freq Band	Rated Power
Wi-Fi 802.11b	W-LAN (USA)	2412 - 2462MHz	39.8 mW
Bluetooth	W-PAN	2402 - 2480MHz	1 mW

FCC INTERFERENCE

NOTE: This equipment has been tested and found to comply with the limits for a Class B digital device, pursuant to Part 15 of the FCC Rules. These limits are designed to provide reasonable protection against harmful interference in a residential installation. This equipment generates, uses and can radiate radio frequency energy and, if not installed and used in accordance with the instructions, may cause harmful interference to radio communications. However, there is no guarantee that interference will not occur in a particular installation. If this equipment does cause harmful interference to radio or television reception, which can be determined by turning the equipment off and on, the user is encouraged to try to correct the interference by one or more of the following measures:

- Reorient or relocate the receiving antenna.
- Increase the separation between the equipment and receiver.
- Connect the equipment into an outlet on a circuit different from that to which the receiver is connected.
- Consult the dealer or an experienced radio/TV technician for help.

This device complies with Part 15 of the FCC Rules. Operation is subject to the following two conditions:

- (1) This device may not cause harmful interference.
- (2) This device must accept any interference received, including interference that may cause undesired operation.

For detailed product safety and RF exposure refer to Safety and General Information leaflet, Motorola publication Number 6802975C53.

Notational Conventions

Throughout this publication, you will notice the use of cautions and notes. These notations are used to emphasize that safety hazards exist, and care must be taken.

Do not proceed beyond a CAUTION until the indicated conditions are fully understood and met.

CAUTION



Indicates a potentially hazardous situation which, if not avoided, may result in minor or moderate injury. CAUTION may also be used to alert against unsafe practices and property-damage-only accident hazards.



Changes or modifications made in the radio terminal, not expressly approved by Motorola, will void the user's authority to operate the equipment.

Trademarks

Motorola and the Motorola stylized M logo are registered trademarks of Motorola, Inc.

FlashFile is a registered trademark of Intel Corporation.

SD is a registered trademark of SanDisk Corporation.

Microsoft and Windows are registered trademarks of Microsoft Corporation.

The Bluetooth trademarks are owned by their proprietor and used by Motorola, Inc. under license in the U.S. and other countries.

All other product or service names are the property of their respective owners.

Contents

COMPUTER SOFTWARE COPYRIGHTS.....	i
<i>Document Copyrights</i>	<i>i</i>
<i>Disclaimer</i>	<i>i</i>
<i>Commercial Warranty</i>	<i>ii</i>
Introduction	3
What is the IMD Handheld Computer	3
Unpacking	4
IMD Features	5
<i>Front Panel and Top Side Features</i>	<i>5</i>
<i>Rear and Bottom Side Features</i>	<i>6</i>
Charging the Battery	7
<i>Battery Installation and Removal</i>	<i>7</i>
<i>To install the battery:</i>	<i>7</i>
<i>To remove the battery:</i>	<i>7</i>
<i>First Time Battery Charge</i>	<i>8</i>
<i>Routine Battery Charge</i>	<i>8</i>
<i>Battery Maintenance</i>	<i>8</i>
<i>Battery Storage</i>	<i>8</i>
<i>Extending Battery Life</i>	<i>9</i>
Using the IMD	10
<i>Turning On the IMD</i>	<i>10</i>
<i>Turning Off the IMD</i>	<i>10</i>
<i>Suspend Mode</i>	<i>10</i>
<i>Visual indications of Power Button/Status LED</i>	<i>11</i>
<i>LED indications when IMD is out of the cradle</i>	<i>11</i>
<i>LED Indications When IMD is in the cradle</i>	<i>11</i>

<i>Using the Keypad</i>	12
<i>Screen Back-Light Adjustment</i>	14
<i>Turning on & off the Screen Back-light</i>	14
<i>Keypad Back-Light Adjustment</i>	14
<i>Turning on & off the Keypad Back-light</i>	15
<i>Capturing Images</i>	16
<i>Resetting the IMD</i>	18
Mini SD Memory Card	19
<i>Installing a Mini SD Card</i>	19
<i>Mini SD Card Handling Precautions</i>	19
Maintaining the IMD.....	20
Accessories	20
Troubleshooting	22
Safety Instructions.....	24
<i>IMD On-board Aircraft</i>	24
<i>Battery Disposal</i>	24
<i>To Prevent Injury or Burns</i>	24
<i>Battery Warnings and Disposal</i>	24
SPECIFICATIONS.....	25

Introduction

This manual covers the basic setup operations and use of the Intelligent Mail Device (IMD) handheld computer.

The IMD may use a variety of Motorola docking cradles for network communication and power charging. Note that this manual briefly describes the basic features of each cradle. For detailed installation and operation of each cradle, refer to the specific user manual of each cradle.

What is the IMD Handheld Computer

The IMD is a rugged handheld computer. The IMD is designed for field applications where fast mail data acquisition and exchange is required.

The IMD serves as a Personal Digital Assistant (PDA) that enables portable access to mobile applications, such as: mobile messaging, queries and Computer Aided Dispatch. It contains a built-in imager for barcode (1D and 2D labels) and signature capturing.

Wireless communication is through 802.11b Local Area Network (LAN, WiFi) and Bluetooth® connection to peripheral equipment.

The IMD display is a QVGA 3.5 inch transfective TFT. Equipped with a back-light, the display is designed to enable clear visibility under all light conditions.

A touch-screen enables easy access to on-screen menu navigation and signature capturing, using stylus or navigation keys. The screen is designed to withstand high impact.

The IMD is equipped with an ABC alpha-numeric keypad. The keypad back-light enables to operate the IMD in low-light conditions.

The operating system is WinCE.net®-based, running Windows® CE-based applications.

The IMD is powered by a 900 mAh 7.2V Lithium-Ion battery pack (1800 mAh battery is also available). The battery is fully recharged within four hours, using the IMD cradles or battery charger.

When battery is replaced, a built-in power source, independent of the battery pack, maintains data in the IMD memory for at least 5 minutes.

Unpacking

The IMD package includes the following items:

- One IMD
- One 900 mAh 7.2V (or 1800 mAh 7.2V) Lithium-Ion battery pack
- One Stylus
- Hand-strap

Carefully unpack each item from the shipping carton. Check all items for shipping damage, and check that you have received all items ordered.

Note: Retain the original carton packaging in the event that the IMD should need to be returned for service.

The IMD is shipped with a plastic film, protecting the screen. Before usage, remove the film and use a soft cloth to buff the screen. A clean screen ensures smooth gliding of the Stylus over the surface.

IMD Features

Front Panel and Top Side Features

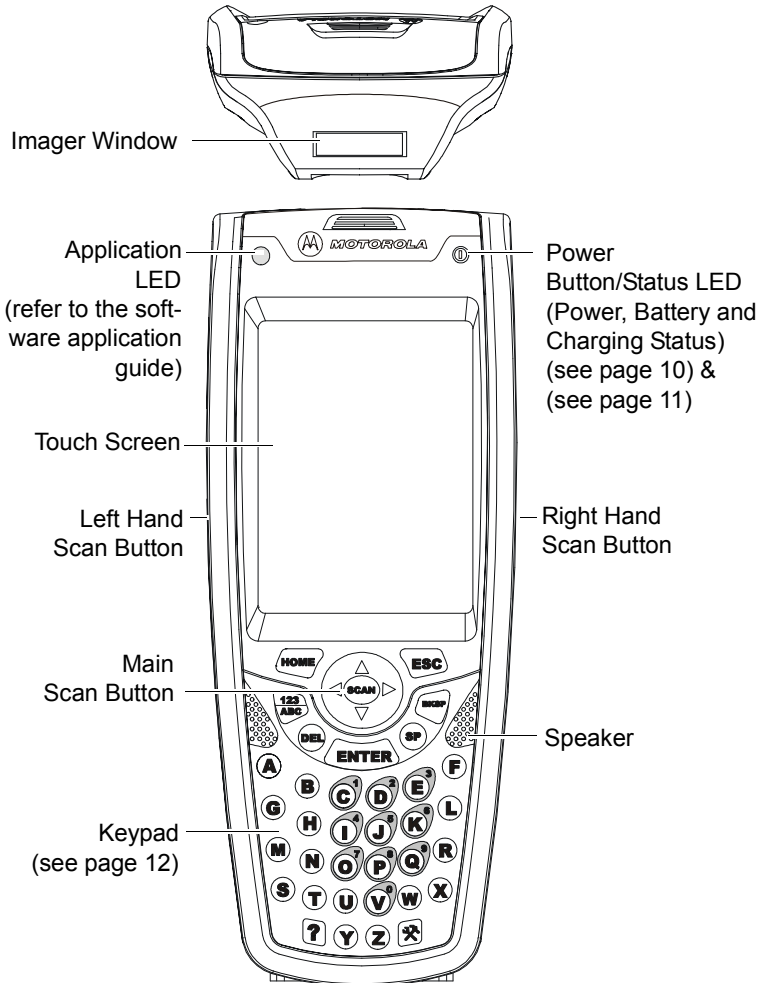

Figure 1. IMD - Front and Top Views

Rear and Bottom Side Features

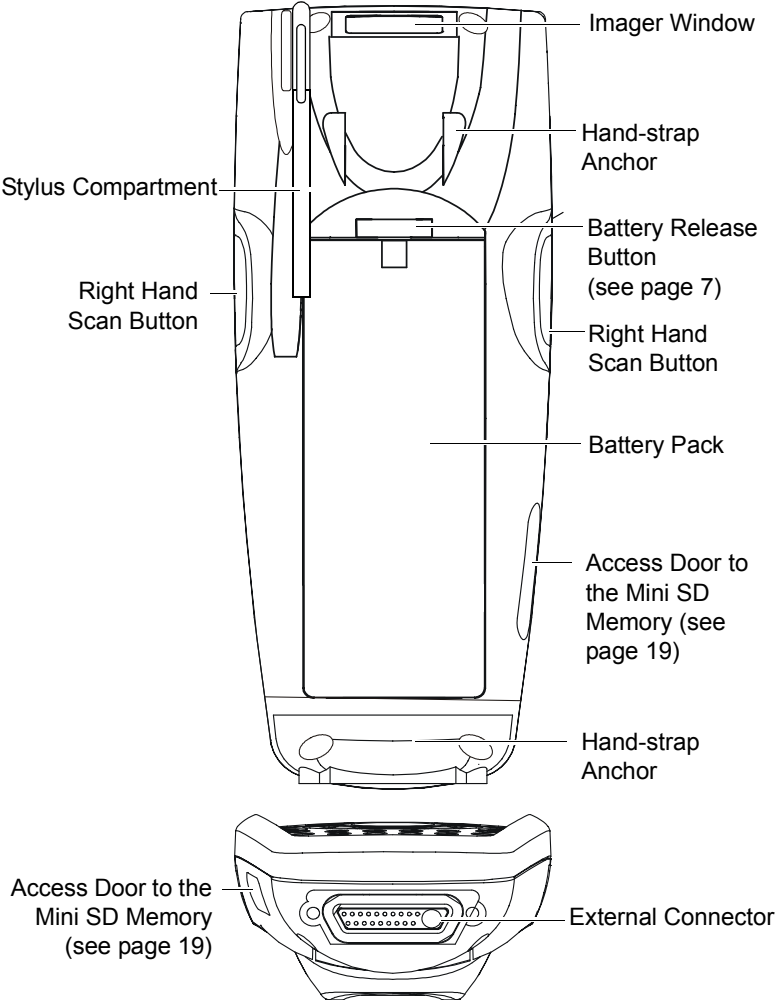

Figure 2. IMD - Back and Bottom Views

Charging the Battery

The IMD battery is charged inside the IMD. The battery is shipped from the factory uncharged and not installed. Install and charge the battery before using the IMD for the first time.

Battery Installation and Removal

Important Note:

The IMD allows you to replace batteries without losing information stored in its memory. To avoid losing information stored in the memory, a charged battery must be installed within five minutes after removing the empty battery.

To install the battery:

1. Disconnect the IMD hand-strap (see Figure 3).
2. Insert the battery, bottom end first, into the battery compartment.
3. Carefully, press the battery top downward until it clicks and locks in place - at this stage, the IMD is ready for charging.

To remove the battery:

Press the release button on the battery (see Figure 3) and pull away the battery from the IMD.

Important: You may remove the battery without turning off the IMD. Once the battery is removed, data will be maintained in the IMD memory for no more than 5 minutes. Re-install the battery.

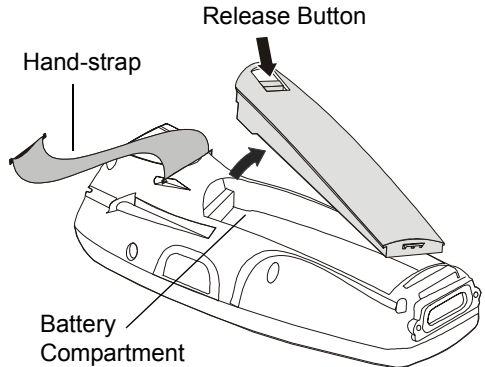

Figure 3. Battery Installation and Removal

First Time Battery Charge

Charge the battery before using the IMD for the first time until the Power Button/Status LED of the IMD shows steady green. While charging, the Power Button/Status LED shows green and blinks quickly.

The IMD Cradle charges the battery most effectively when it is at room temperature [approx. 68°F (20°C)]. Battery charging temperature range is 32°F to 95°F (0°C to 35°C).

Routine Battery Charge

A battery is charged to 90% of its full capacity after approximately three and a half hours. The battery is fully charged after four hours. During the charge, the Power Button/Status LED shows steady red and turns green when charging is completed.

Important: The battery will not charge if the IMD is not properly docked inside the IMD Cradle.

Battery Maintenance

The performance of the rechargeable battery delivered with the IMD depends on the way the battery is treated. Therefore, to comply with Motorola Warranty for batteries and to assure high performance and a long life for the rechargeable battery, please read and follow the battery maintenance sections below.

Battery Storage

Do not store the battery where the temperatures exceed 140°F (60°C) or fall below -4°F (-20°C).

Batteries that have never been charged before may be stored for up to 3 months in well-ventilated, cool and dry areas without significant loss in lifespan.

Batteries which have already been charged and then stored for more than 2 months should be recharged before use.

Extending Battery Life

A battery is an expendable part and may need replacing during the life of the IMD. To ensure maximum service life of the IMD, always replace the battery with a genuine Motorola replacement.

The IMD Cradle will charge the battery most effectively when it is at room temperature [approx. 68°F (20° C)]. Battery charging temperature range is 32°F to 95°F (0°C to 35°C).

Using the IMD

Turning On the IMD

Press the Power Button/Status LED (see Figure 1) to turn on the IMD.

Turning Off the IMD

When the IMD is On, hold the Power Button/Status LED pressed for at least four seconds - the IMD will remember the last used screen and will go into deep sleep mode - no information will be lost. Once turned on again, the IMD will show the last screen that was in use.

Suspend Mode

When the IMD is turned on, momentarily press on the Power Button/Status LED to enter Suspend mode (see Figure 1). During Suspend mode the display turns off and the Power Button/Status LED slowly blinks green. To resume operation, press momentarily on the Power Button/Status LED again.

In Suspend mode, battery power is saved by an automatic turn off of the display and the computer sections of the IMD. During Suspend mode, the Bluetooth radio continues to operate. When the IMD resumes operation, it returns to the screen shown prior to Suspend mode.

The IMD may also move to Suspend automatically if not in use for some time.

Use Suspend mode as often as possible to conserve battery power.

Visual indications of Power Button/Status LED

The Power Button/Status LED has a 3 color LED (red/yellow/green) to indicate the power, battery and charging status (see Figure 1).

The LED indications differ when the IMD is used out of the cradle and inside the cradle.

LED indications when IMD is out of the cradle

LED **slowly blinks green** - IMD in Suspend mode.

LED shows **steady red for 5 seconds** - IMD is booting-up following battery replacement. **Important:** to avoid system failure, do not remove the battery during boot-up.

LED Indications When IMD is in the cradle

LED shows **steady red** - battery is charging.

LED shows **steady green** - battery is fully charged.

LED **blinks yellow** - battery temperature or voltage is out of range - battery charging is stopped. Charging will resume when temperature or voltage is back within range.

LED **blinks red** - charging error/bad battery. Re-install the IMD in the cradle or replace battery.

Using the Keypad

The IMD keypad enables the user to input both alphabetic and numeric data to the software application. However, since the keypad can only contain a limited number of keys, some special keys are assigned to perform special tasks that are usually found on full-size computer keyboards. These are produced using a combination of the existing keys on the IMD keypad.

Two sets of keys exist on the IMD:

1. Keys active when in Alphabetic mode, which are those seen on the overlay of the IMD keypad.
2. Keys active when in Numeric mode which are those seen in the numbered oval shapes on the IMD keypad.

Press the “Alpha-numeric” key to toggle between the Alphabetic and Numeric modes

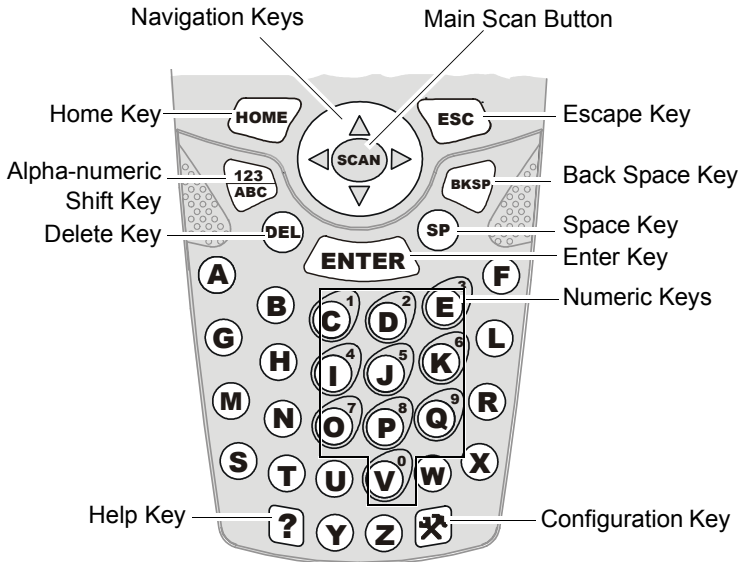

Figure 4. IMD - Key Function

<SCAN>: The Imager trigger button is used for scanning images (refer to "Capturing Images" on page 16).

<ENTER>: The <ENTER> key is used to continue to the next screen (i.e. continue processing).

Navigation Keys: The <Up Arrow> and <Down Arrow> keys are used to scroll up and down on menu, form and data list screens. The <Right Arrow> and <Left Arrow> are used for horizontal navigation between action buttons and areas such as: date controls, time controls, data table controls, and for closing list boxes.

<Home>: The <Home> key serves as an Esc key The <Home> key is used to cancel the current action and return to the previous screen or possibly display a confirmation screen. Any data entered on the screen via scanned entry, keyed entry, or menu selection is ignored. the key is also used to closes list boxes, combo boxes and pop up windows without changing the data.

****: The key deletes the character at the current cursor position in the field. The key is only active on data entry screens.

<SP>: Enables to enters blank space within a text field. The <SP> key is active only on those text entry screens which contain fields that allow spaces to be entered.

<BKSP>: The <BKSP> key moves the cursor to the previous character in the field, and erases the character in its new position. Any remaining characters to the right of the cursor are shifted to the left by one. If there are no more characters to erase, the Scanner beeps. The <BKSP> key is only active on data entry screens.



<123/ABC>: The Alpha-numeric key shift between alphabetic and numeric keypad modes to shift between digit entry and letter entry. For example, the '8' key in non- <123/ABC> mode becomes "B".

Press <123/ABC> + any alphabet key for uppercase letter (Default is lowercase letters).

? Help: This key is pressed to popup help window when Help application is available. To know more about the key, consult the software application guide of the IMD.

✚ Configuration: The configuration key is pressed to popup maintenance application window, when maintenance application is available. To know more about the key, consult the software application guide of the IMD.



Screen Back-Light Adjustment

The screen Back-light can be adjusted by simultaneously holding  pressed and pressing the up or down arrows  to increase or decrease the screen Back-light.

Turning on & off the Screen Back-light

Hold  press for 2 seconds - the screen Back-light will turn on. To turn off - hold pressed for another 2 seconds. When not in use, Back-light turns off automatically after 10 seconds.

Keypad Back-Light Adjustment

The keypad back-light can be adjusted by simultaneously holding  pressed and pressing the right or left arrows  to increase or decrease the screen back-light.

Turning on & off the Keypad Back-light

Hold  press for 4 seconds - the screen Back-light will turn on. To turn off - hold pressed for another 2 seconds.

When not in use, Back-light turns off automatically after 10 seconds.

Capturing Images

The IMD houses a digital camera (Imager) that captures pictures and decodes the most commonly used 1D and 2D bar codes. The IMD supports 360° omni-directional operation for easy use in daily work. The Imager captures digital images, such as signatures, text or pictures of any object or form. The images are stored in the IMD memory.

To capture an Image:

1. Aim and hold the IMD at approximately 2 to 12 inches (5 to 30 cm) away from the target.
2. Press the Imager Scan button and aim the green aiming pattern towards the target to adjust your position. Note that when the IMD is held closer to the barcode the green aimer appears smaller when held farther from the barcode it appears larger. Barcode symbols with dense symbol elements should be read closer to the IMD and large barcode with larger symbol elements should be read at a larger distance (Depth-of-Field) from the IMD.

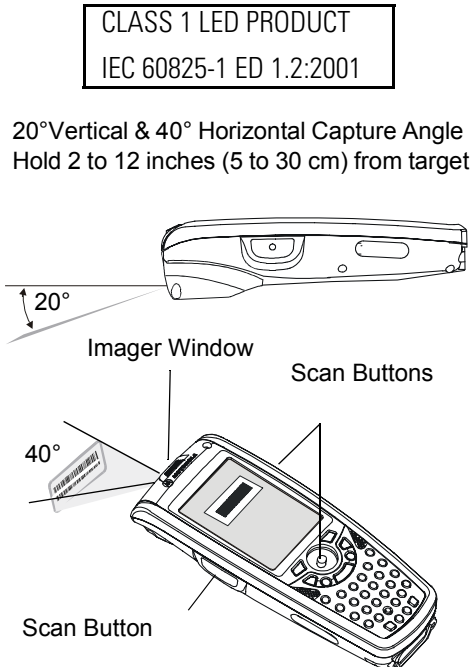

Figure 5. Capturing Images with the IMD Imager

To capture a barcode, aim the green aimer bar in any angle across the barcode, as shown in Figure 6

1D Barcode Symbol



2D Barcode Symbol

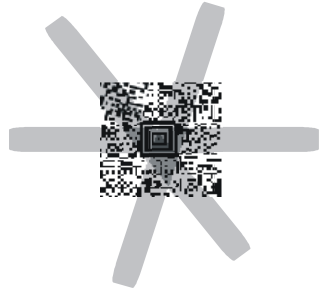

Figure 6. IMD Imager - Barcode Capture Position

Note: When adjusting your position, you may move back and forth from the target to capture the entire object - a successful scan may be followed by sound indication.

Resetting the IMD

You may need to reset the IMD; for example, you may reset due to communication cut-off, or if the operating system or the application stops responding.

If the IMD stops responding, perform the following steps:

Step 1: Warm Reset

Important Note: When the IMD performs Warm Reset, all recorded information remains stored in memory.

Simultaneously, press keys

ESC + A + F (see Figure 7) for at least 5 seconds - the Motorola logo will show on the screen for about 30 seconds and then WinCE desktop will appear - the IMD functions again.

If the IMD still does not respond, perform "Step 2: Cold Reset":

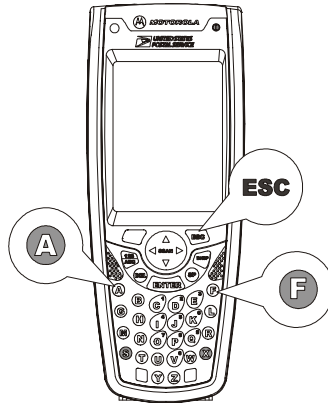

Figure 7. Warm Reset - Key Combination

Step 2: Cold Reset

Cold Reset restarts the IMD by erasing all stored records and entries.

Do Not perform Cold Reset unless Warm Reset fails to solve the problem.

Press the **Power Button/Status LED + S + X** keys simultaneously for at least 5 seconds (see Figure 11); the IMD will restart its operating system.

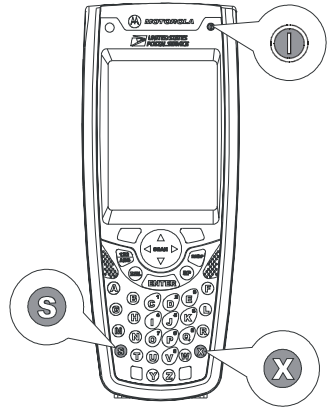

Figure 8. Cold Reset - Key Combination

Mini SD Memory Card

Installing a Mini SD Card

1. Turn off the IMD.
2. Remove the screw to open the cover of the Mini SD (Secure Digital) card slot (see Figure 2).
3. Insert the Mini SD card as shown in Figure 9.

Important: Turn the IMD power off before removing or installing the Mini SD card.

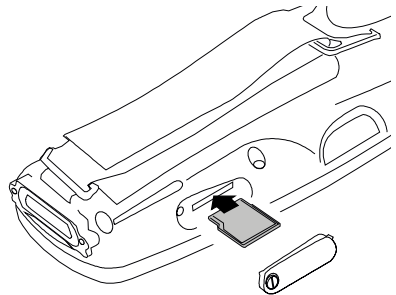

Figure 9. Mini SD Card Installation

Mini SD Card Handling Precautions

- Use only the supplied Mini SD card.
- Do not bend or apply force on the Mini SD card.
- Do not store the Mini SD card in locations subjected to high humidity or temperatures.

Maintaining the IMD

In order to maintain the IMD in good working order:

- Do not scratch the screen. Use only Motorola supplied stylus pen.
- Never use a pen or pencil or any sharp object on the screen.
- Protect the IMD from temperature extremes. Do not leave the IMD on the dashboard of a car on a hot day, and keep the IMD away from hot places.
- Do not store or use the IMD in any location that is extremely dusty, damp or wet.
- If the battery contacts, screen or surface of the IMD become dirty, use a soft lint free cloth moistened with diluted Isopropyl Alcohol (IPA) solution to remove dirt. The Isopropyl Alcohol (IPA) can be diluted with water up to 20%.

Accessories

The following Motorola approved accessories are for use with the IMD.

Table 1: Accessories

Motorola Approved Accessory	Part Number
IMD Communication/Charger Cradle 8 Bays	F3147
IMD Communication/Charger Cradle 4 Bays	F3141
IMD Communication/Charger Cradle 2 Bays	F3149
IMD Communication/Charger Single Bay	F3146
IMD Vehicle Cradle	F3128
IMD 8 Slot Multi-Battery Charger	F3142
IMD Battery 1800 mAh	FNN7815

Table 1: Accessories

Motorola Approved Accessory	Part Number
IMD Battery 900 mAh	FNN7818
IMD Stylus	0104611P06
IMD Holster	FTN646
IMD Hand-strap	FHN6621

It is the responsibility of the user to use only the approved accessories supplied for this product, as detailed in Table 1 . Motorola is not responsible for the use of accessories not approved for this product.

For more information on the availability of these accessories, please call your company supplier.

Troubleshooting

Table 2: Troubleshooting the IMD

Problem	Cause	Solution
IMD does not turn On	Battery is not installed properly or not charged	Ensure proper battery installation in IMD. Charge or replace the battery
	IMD in Suspend mode	Press the Power Button/Status LED
Battery does not charge in IMD Cradle	IMD is not locked in IMD Cradle	Re-install IMD in IMD Cradle. Place the IMD properly in IMD Cradle. (Verify that the IMD Cradle LED is On and charge for three hours)
	IMD Cradle contacts are not clean	Clean contacts and remove dust and objects from within the IMD Cradle
	Battery temperature is out of range	Ensure that the battery temperature is within range. (refer to "Charging the Battery" on page 7)
	Bad battery	Replace battery
IMD does not detect scan input	Aiming pattern not directed to the barcode symbol	Scan again and make sure that the green light is aimed across the barcode Check for readable barcode (not covered, or abstracted)
	Unreadable barcode	Be sure the barcode symbol is not covered, damaged or obstructed

Table 2: Troubleshooting the IMD

Problem	Cause	Solution
IMD does not respond	Problem in IMD operating system or communication network	<p>Ensure proper battery installation in IMD. Charge or replace the battery</p> <p>Execute Warm Reset “Resetting the IMD” on page 18. The IMD should function again</p> <p>If IMD still does not respond, perform Cold Rest (see “Resetting the IMD” on page 18). The operating system will reboot in 30 seconds</p>
Incomplete or no data transmission between IMD and IMD Cradle	Communication software was incorrectly installed or configured	Refer to the IMD Cradle user manual or see your system administrator

Safety Instructions

IMD On-board Aircraft



Battery Warnings and Disposal

Always remove the battery from the IMD when shipped via air. Any use of the IMD must be in accordance with applicable regulations per airline crew instructions.

Battery Disposal

Batteries must be recycled or disposed of properly in accordance with local requirements. Recycling facilities may not exist in all areas. Please contact your local environmental agency for more information regarding proper disposal.

To Prevent Injury or Burns

- USE ONLY SPECIFIED BATTERIES AND CHARGERS - RISK OF EXPLOSION IF BATTERY IS REPLACED BY AN INCORRECT TYPE!
- DO NOT DISPOSE OF ANY BATTERIES IN FIRE, AS THEY MAY EXPLODE!
- DO NOT PUNCTURE OR ALLOW METAL TO CONTACT THE BATTERY TERMINALS
- DO NOT DISPOSE OF IN WATER
- DO NOT DISASSEMBLE
- DO NOT STORE ABOVE 140°F (60°C) OR BELOW -4°F (-20°C)

SPECIFICATIONS

PHYSICAL SPECIFICATIONS

Weight	16.1 Ounces (461 g), including the standard capacity battery (900 mAh)
Dimensions	Width x Length x Depth: 3" x 7.7" x 1.93" (77.8 x 197.6 x 49 mm)

ELECTRICAL SPECIFICATIONS

Power Supply	From external connector (Cradle connection): 10 to 15VDC, maximum current 1.5A
	From Li-Ion battery pack: 5.4 to 8.4VDC, maximum current 1.5A,

Processor Type	Intel PXA270
Memory	Flash: 64 MB (128 option), SDRAM: 64 MB
Display	3.5" color, transfective, 64K color LCD with up to 55 cd/m ² (NIT) luminance. Resolution: 240 x 320 pixels (1/4 VGA)
Touch Screen	Resistive analog 4-wire touch panel. Ten bit resolution digitizer with 1024 X 1024 points.

Keyboard	36 keys: <ul style="list-style-type: none">- 26 alpha (A-Z) keys- 4 scroll keys- 2 soft (programmable) function keys- 3 scan keys, one front mounted and one on each side of the terminal- 7 function keys- 1 power on/off key with 3 color LED
Status Indicator	Two Tricolor LEDs: <ol style="list-style-type: none">1. Software controlled2. Integrated inside Power button
Audio	Speaker: Mono 0.5 W speaker for producing audible alerts. adjustable volume. The sound pressure level at 10 cm is at least 75 dBA at 2,200 Hz.
Personal Area Network (PAN)	Bluetooth V1.2 port communication to wireless accessories

Barcode Imager	<p>IT4100SR: Image Engine with Adaptus™ imaging technology that implements area imaging for both 1D and 2D reading as well as capture of signatures.</p> <ul style="list-style-type: none"> - Lighting conditions ranging from complete darkness to 100,000 lux [depth of field specification may be reduced under conditions of less than 535 lux (50fc)]. - Viewing angle around the normal at the nominal operating distance, pitch and skew: 40° <p>Rotation around the optical axis: 360° The scanner may not operate under conditions of spectral reflection +/- 5°</p>
Main Battery	<p>Lithium-Ion, 7.2V, 900 mAh (1740 mAh optional). Fully recharged within 4 hours in cradle.</p>
Backup source	<p>A secondary (backup) power source comprising two "super-caps", independent of the primary battery. The capacitors provides backup for at least 5 minutes while the main battery is replaced.</p>

Software

Operating System

WinCE.net®-based operating system (running Windows® CE-based applications)

Communication

Personal Area Network (PAN): Bluetooth 1.2 RF communication to wireless equipment

Wi-Fi Wireless Local Area Network (WLAN) with integrated antenna for software debugging:
Network Standard IEEE 802.11b
Frequency Band 2.400-2.474 GHz (2.4 GHz ISM Band)

Full RS-232 serial port and USB 1.1 client port for wired connections to Communication network cradle and peripheral devices such as printers

ENVIRONMENTAL SPECIFICATIONS

Operational Temperature (without degradation)	32° F (0° C) to 122° F (50° C). See below * for operation between -18° F (-28° C) to 32× F (0° C)
Storage Temperature	-22° F (-30° C) to 158° F (70° C), 24 hours soak, without battery
Humidity	8 hours at 122° F (50° C) 5-95% RH with power off during soak time. The unit will then be turned ON and fully tested while in the temp & humidity conditions. Battery charging is automatically stopped above 95° F (35° C).
Dripping Rain	MIL-STD-810F, Method 506.4 Proc II – water tightness
Altitude	According to IEC 68-2-13/MIL-STD-810F, Method 500.4 Operating 15,000 ft (4.5 km)
Blowing Dust	MIL-STD-810F, Method 510.4 Proc I – blowing dust
Shock (Functional)	Total 18 impacts, hard mounted. Operating: 15g, 11ms, half sine wave Non-operating: 30g, 11ms, half sine wave
Vibration	Duration 1 hour/axis, hard mounted. Operating: 10-55 Hz, 0.075 mm, 55-500 Hz, 1.0g Non-operating: 10-55 Hz, 0.15 mm, 55-500 Hz, 2.0g
Drop	MIL-STD-810F, Method 516.5, 26 drops from 4 ft. high. Test surface: concrete
Enclosure Class (Rain & Dust)	IP X4 (Rain) IP 5X (Dust) Category 2 (no vacuum pump)

ESD	Per EN61000-4-2 8 KV contact, 15 KV air. No permanent failure or loss of data, reset is allowed.
Radiation & Susceptibility Approvals	FCC 47CFR part 15, subpart A and C. EN 55024:1998, IEC801-3, IEC801-4, EN50082-1 & -2
Safety	UL marking based on UL 60950-1

* Operational Temperature with degradation (based on Motorola testing)	LCD	From -18° F (-28° C) to 32° F (0° C): Response time up to ½ sec Min. Contrast: – Reflective 2:1 – Transmissive 20:1 Backlight – No degradation
	Imager	From -18° F (-28° C) to 32° F (0° C): Near Field DOF – 40% degraded Far Field DOF -20% degraded
	Touch Screen Activation Force	From -18× F (-28° C) to 32° F (0° C): 0.53 to 5.64 oz. (15 to 160 gm)

Battery Degradation	At 14° F (-10° C): 85%
(% of capacity	At -4° F (-20° C): 50%
w/temp, 100%	At -18° F (-28° C): 35%
at 77× F (25° C),	
0.2C discharge	
rate.)	

Index

A

Accessories 20
Aircraft 24

B

Battery Charge 8
Battery charging temperature 8
Battery Maintenance 8
Battery Storage 8
Battery Warnings 24

C

Charging 7
Cold Rese 19
cool and dry areas 8

D

Disposal 24

E

Extending Battery Life 9

I

Injury 24
Install Battery 7
Isopropyl Alcohol 20

L

Laser Warning 16
LED shows green 8
LED shows red 11

M

Maintaining 20

N

Navigation Key Panel 6

P

PowerPad Parts 5

R

Remove Battery 7
Resetting 18
room temperature 8

S

Safety Instructions 24
Scan Angle 16
Scanning 16
Speaker 5
storage temperatures 8
store 20
Suspend Mode 10

T

Touch Sensitive Screen 5
Troubleshooting 22
Turning Off 10
Turning On 10

U

Universal Office Docking 8
Unpacking 4

W

Warm Reset 18

***HOW TO REACH US:
Government & Enterprise
Mobility Solutions***

1301 E. Algonquin Road,
Schaumburg, IL 60196

Tel: 1-888-567-7347 (inside the US)

Tel: 1-847-576-5000 (outside the US)

Visit our Web site at
www.motorola.com



MOTOROLA
intelligence everywhere™

MOTOROLA and the Stylized M Logo are registered in the U.S. Patent and Trademark Office. All other product or service names are the property of their respective owners.

© Motorola, Inc. 2005.